

# **CARILLON BELL SYSTEM**

[www.BRGProducts.com](http://www.BRGProducts.com)



## **CBS4500 Quick Start Guide**

# Parts Checklist

---

Unbox and inspect all parts of your BRG Carillon System.

**DO NOT REMOVE ANY LABELS  
FROM THE COMPUTER OR  
EQUIPMENT**

You should have received:

- All-in-one Carillon Computer with desktop speakers, keyboard, mouse, mousepad, and power cord
- USB sound card
- RCA “Y” cable
- RCA to XLR adapter
- DA1000 3200 watt amplifier with power cord
- Speakon adapter with “pigtail”
- Power strip
- RF Remote Receiver and Amplifier Relay with remote, USB cable, and power cord
- 250ft roll of two conductor speaker cable
- (4) x OS100 100 watt outdoor speaker drivers with cones
- Water resistant junction box with wire nuts

**If any piece is damaged or missing, please call Carillon  
Technical Support at 1-800-295-0220 or email us at  
[carillonsupport@brgproducts.com](mailto:carillonsupport@brgproducts.com)**

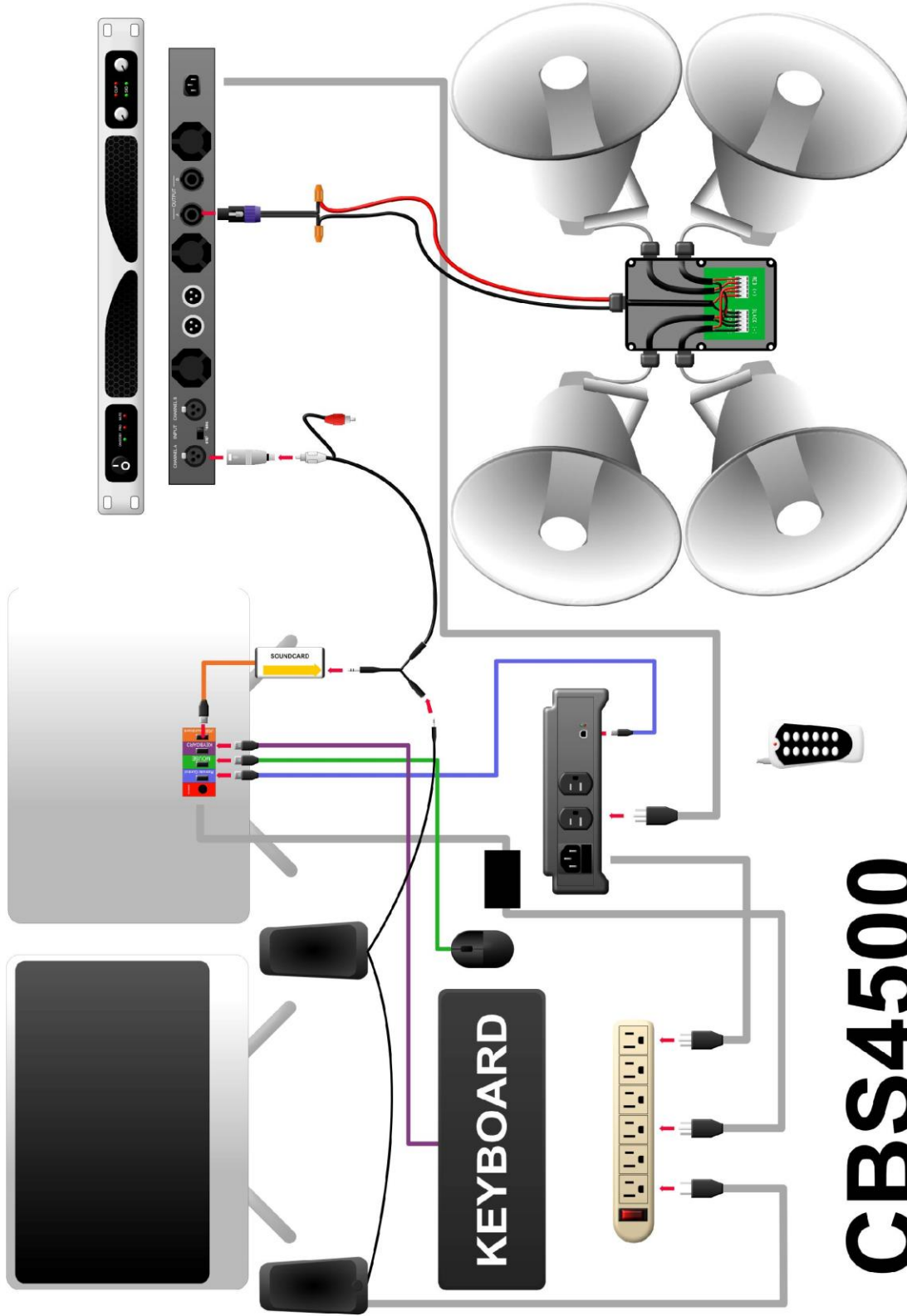

# CBS4500

Hookup Diagram

# Connecting the Speakers

Mounting the speakers may require additional help. If a member of the organization is not available to install the speakers, it is recommended to use a local electrician or A/V installation company. This is also beneficial as they will have the tools necessary to fish wire or test connections if needed. Before installing the speakers it is important to run the included speaker wire to the installation locations.

## Step 1:

Mount the speakers in their desired locations.

## Step 2:

Next, wire the Junction Box. The Junction Box will have two terminal blocks labeled “RED (+)” and “BLACK (-).” You will connect all positive wires to the block marked “RED (+)” and all negative wires to “BLACK (-).”

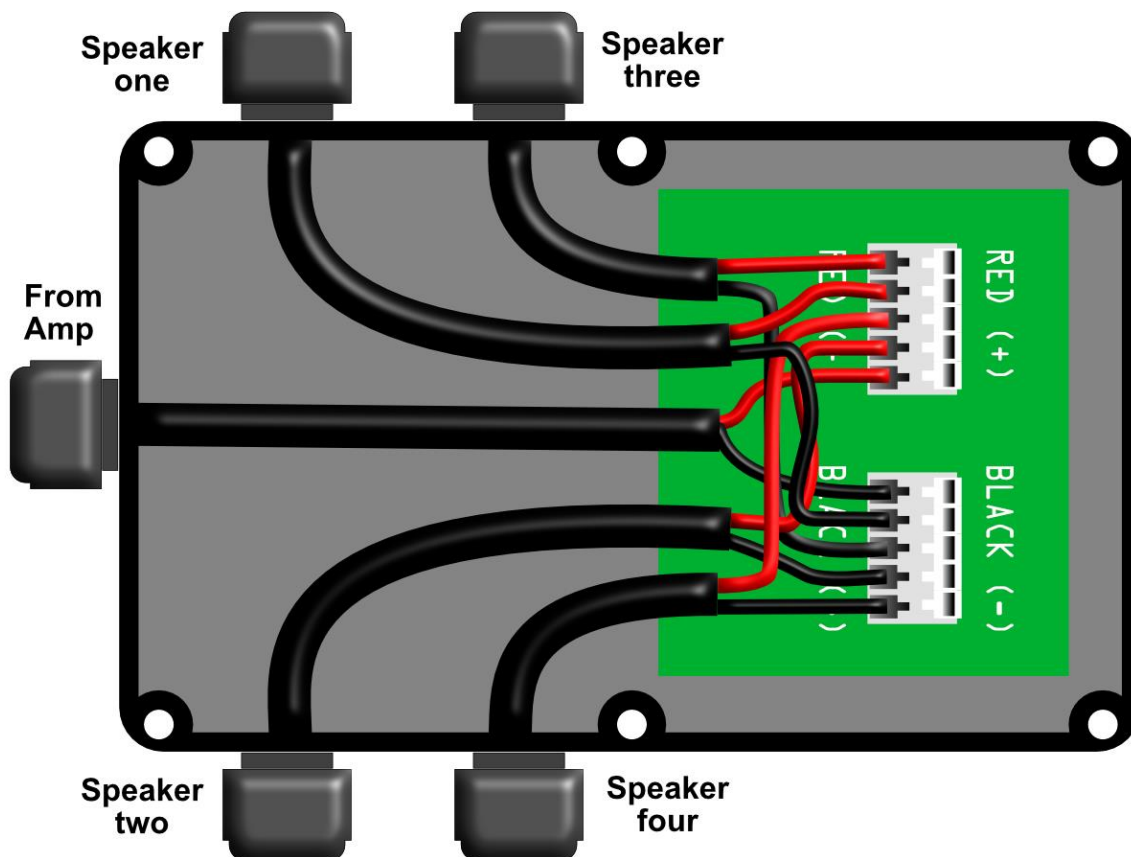

Strip back  $\frac{1}{4}$  to  $\frac{1}{2}$  inch of each wire exposing the core. Use a small screwdriver or similar tool to open each terminal by pushing straight back on the corresponding white tab. This will open the terminal and you can place the stripped end of the wire through.

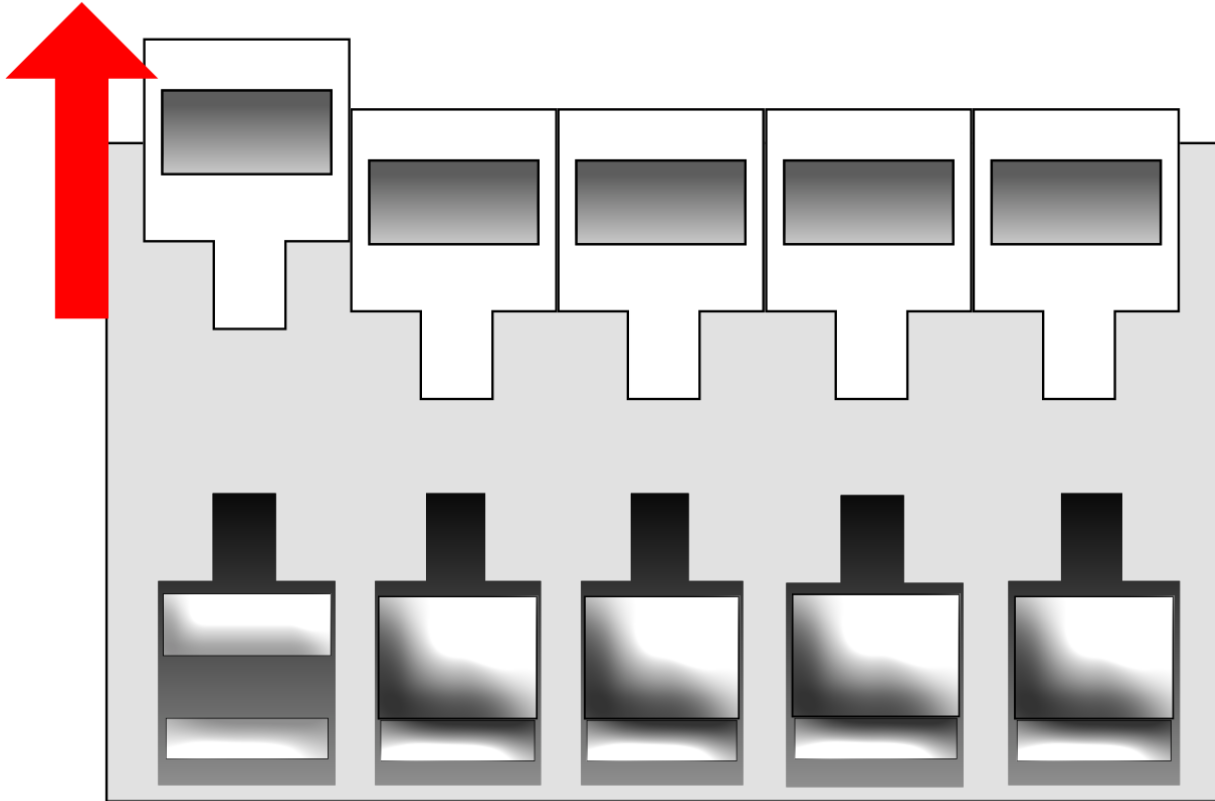

# Connecting the Computer

---

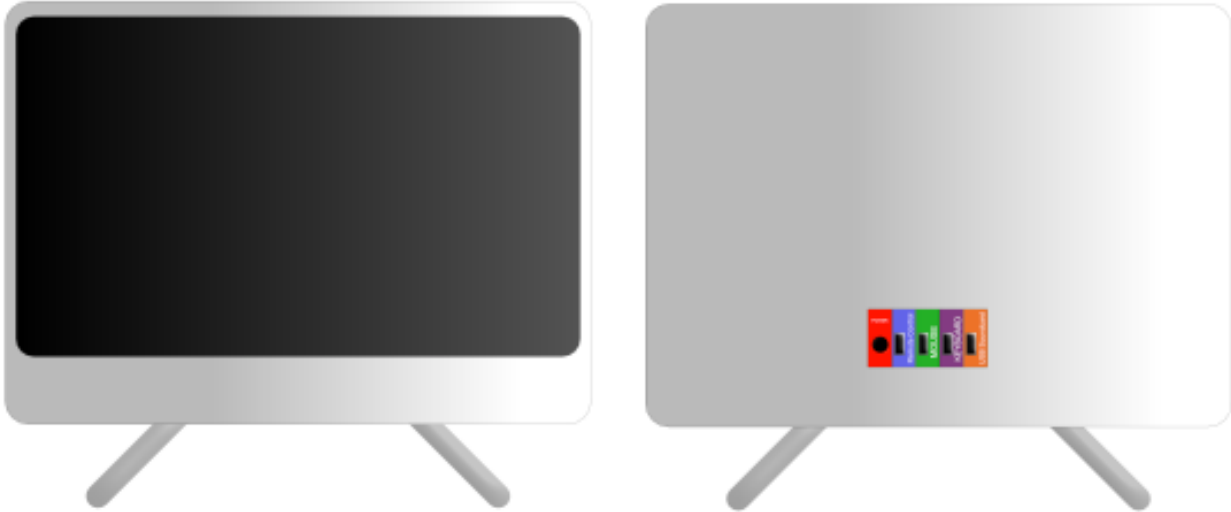

For convenience, all connections are color coded or labeled.

**WARNING:** DO NOT CONNECT THE COMPUTER TO A NETWORK OR THE INTERNET • DO NOT INSTALL ANY SOFTWARE ON THE COMPUTER UNLESS INSTRUCTED BY BRG TECHNICAL SUPPORT • DO NOT SET A PASSWORD FOR THE COMPUTER • DO NOT PUT THE COMPUTER TO SLEEP • THE CARILLON COMPUTER SHOULD RUN 24/7 AND WILL AUTOMATICALLY RESTART EACH MORNING TO PERFORM SELF-CHECK FUNCTIONS AND CLEAR ANY FAULT

**Step 1:**

Connect all of the USB connections. The back of the computer has a color coded label that looks similar to this.

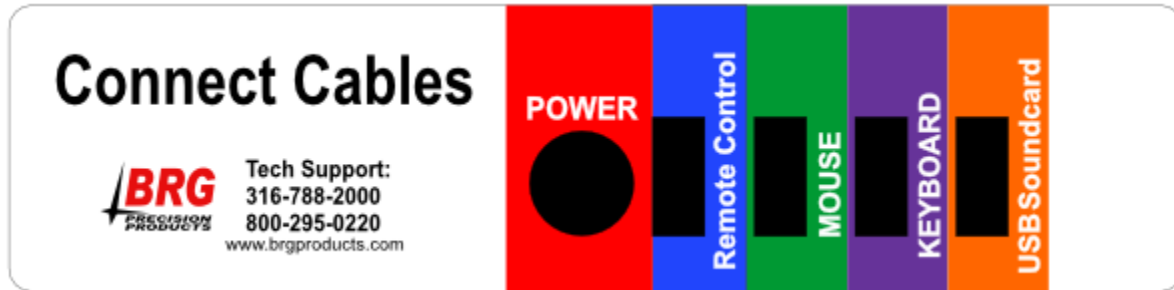

NOTE: Sticker may vary slightly

Remote Control= RF Remote Receiver and Amplifier Relay

MOUSE= Mouse

KEYBOARD= Keyboard

USB Soundcard= Soundcard

**Step 2:**

Connect the RCA “Y” Cable into the soundcard in the jack indicated by the yellow arrow.

**Step 3:**

Connect the green 1/8<sup>th</sup> inch male stereo connector from the desktop speakers to the 1/8<sup>th</sup> inch female jack on the “Y” Cable

**Step 4:**

Connect the power cables of the Computer, RF Remote Receiver and Amplifier Relay, and Desktop Speakers to the included power strip. Make sure the switch on the power strip is in the “ON” position. You should see a red light on the Relay, as well as power to the desktop speakers.

**Step 5:**

Turn on the computer.

# Connecting the Amplifier

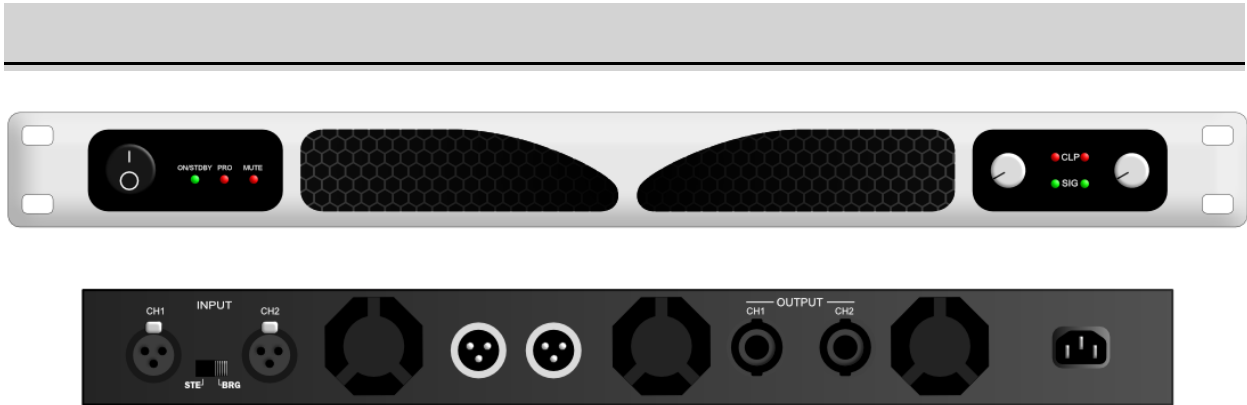

## Step 1:

Connect the silver RCA to XLR adapter to Channel 1's input on the back of the amplifier.

Connect the white RCA connector of the "Y" cable to the RCA to XLR adapter. (The Red RCA Cable is only used for certain applications)

Connect the purple Speakon connector to Channel 1's output.

## Step 2:

Wire nut the red and black speaker wire from the junction box to the Speakon cable "pig tail." NOTE: The black wire with the texture or without writing on the "pig tail" is the negative (black).

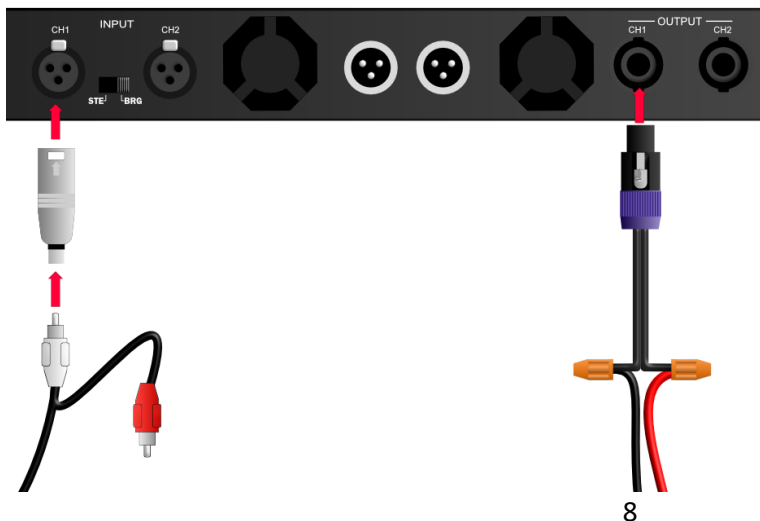



### **Step 3:**

Connect the power cable from the amplifier to one of the outlets on the RF Remote Receiver and Amplifier Relay. **NOTE:** The outlets on the relay are Safety Outlets and require a bit of force to open the white protective barrier. This is expected.

### **Step 4:**

Set the power switch on the amplifier to the “ON” position indicated by the solid line. If the green light on the relay is not illuminated, then the amplifier will not turn on. This is expected behavior.

### **Step 5:**

Setting the amplifier volume may require more than one person with someone outside to listen to the speakers.

In the Carillon program, select a song by highlighting it. Then click play. You will get a message below the play button that says “Play Delayed While Powering on Amplifier.” You should hear the amplifier turn on. The power light will switch to green. The MUTE light will turn red for a few seconds and then shut off. At this time, the song should be playing. Starting with the amplifier at its lowest setting, slowly rotate the volume of Channel 1 until the outside speaker volume is at an acceptable level.

**Note:** You may need to repeat this step in order to achieve the best volume.

Once set, the amplifier will shut off on its own. Leave everything powered on and the preprogrammed bell schedule should automatically play.

## **Thank you!!!**



We hope you enjoy your BRG Carillon System. If you have any questions, comments, or concerns do not hesitate to reach out by calling 1.800.295.0220